

Gegevensblad | Artikelnummer: 221-613

Verbindingsklem / Universele klem COMPACT; 3-draads klem; met bedieningshendels; max. omgevingstemperatuur 85°C

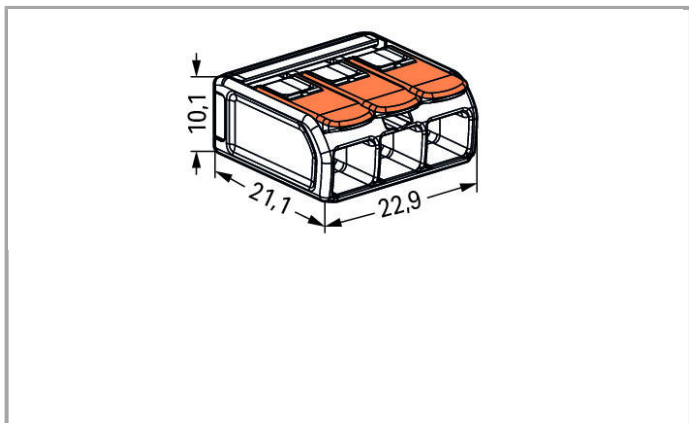

www.wago.com/221-613

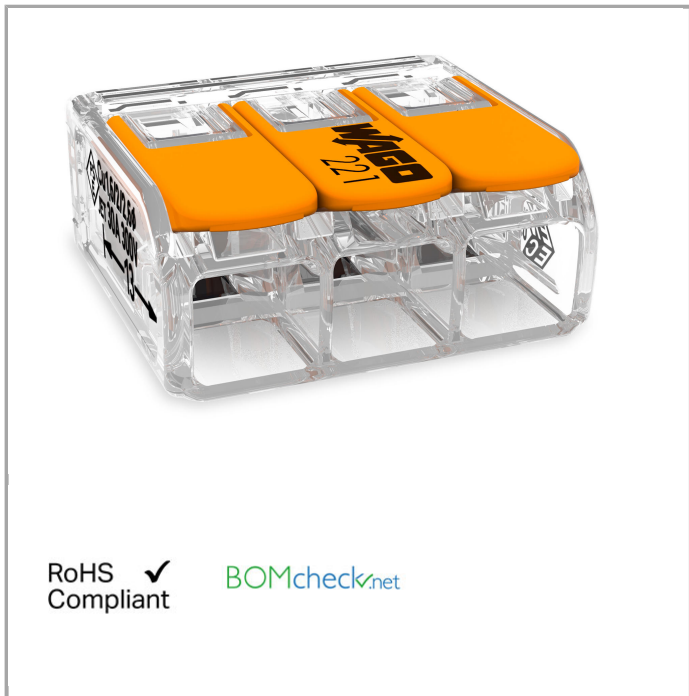

Gegevens
Elektrische gegevens



Ratings per IEC/EN 60664-1

Toegekende spanning (II / 2)	450 V
Toegekende piekspanning (II / 2)	4 kV
Toegekende stroom	41 A
Legenda dimensioneringsgegevens	(II / 2) \triangleq Overvoltage category II / Pollution degree 2

Aansluitgegevens

Aansluittechniek	CAGE CLAMP®
Bedieningswijze	Bedieningshendel
Aansluitbare geleidermaterialen	Koper
Nominale doorsnede	6 mm ²
Massieve geleider	0.5 ... 6 mm ² / 20 ... 10 AWG
Meeraderige geleider	0.5 ... 6 mm ² / 20 ... 10 AWG
Fijnaderige geleider	0.5 ... 6 mm ² / 20 ... 10 AWG
Afstriplengte	12 ... 14 mm / 0.47 ... 0.55 inch
Totaal aantal klemposities	3
Totaal aantal potentialen	1
Soort bedrading	Bedrading met zij-invoer

Geometrische gegevens

Breedte	22.9 mm / 0.902 inch
Hoogte	10.1 mm / 0.398 inch
Diepte	21.1 mm / 0.831 inch

Materiaalgegevens

Kleur	transparant
Brandbaarheidsklasse conform UL 94	V2
Gewicht	4.014 g

Omgevingsvoorwaarden

Omgevingstemperatuur (bedrijf)	85 °C
T-Marking per EN 60998	T85

Commerciële gegevens



Verpakkingswijze	BOX
Country of origin	DE
GTIN	4055143715416

Vergunningen / certificaten



Landspecifieke goedkeuringen

Logo	Vergunning	Certificaatsnaam
	KEMA/KEUR DEKRA Certification B.V.	71-101850

Scheepsgoedkeuringen



Logo	Vergunning	Certificaatsnaam
	DNV GL Det Norske Veritas, Germanischer Lloyd	TAE000015T
	LR Lloyds Register	04/20013 (E6)

UL-goedkeuringen

Logo	Vergunning	Certificaatsnaam
	UL Underwriters Laboratories Inc.	E201573
	UL Underwriters Laboratories Inc.	E69654

Relevante producten

Mounting adapter

	Artikelnr.: 221-510 Bevestigingsadapter; Serie 221 - 6 mm ²	www.wago.com/221-510
	Artikelnr.: 222-505 Trekantlastingsplaat; voor bevestigingsadapter; Serie 221 of 222, opklikbaar	www.wago.com/222-505

Downloads

CAX-gegevens

CAD-gegevens

3D Download 221-613	URL	Download
---------------------	---------------------	--------------------------



Wijzigingen voorbehouden

WAGO Kontakttechnik GmbH & Co. KG

Hansastr. 27

32423 Minden

Phone: +49571 887-0 | Fax: +49571 887-169

Email: info.de@wago.com | Web: www.wago.com

Hebt u vragen over onze producten?

U kunt ons telefonisch bereiken op het nr. +31 55 3683500.